

## Drop-In

### Drop-in remote refrigerated stainless steel surface (6 GN container capacity)

ITEM # \_\_\_\_\_

MODEL # \_\_\_\_\_

NAME # \_\_\_\_\_

SIS # \_\_\_\_\_

AIA # \_\_\_\_\_

**341113 (D14R6)**

Drop-in remote refrigerated stainless steel surface (6 GN container capacity)

### Short Form Specification

#### Item No.

Designed to be positioned in flush installation providing improved cleanability and suitable for modern design installations. Designed to serve the food on plates. Food introduced at the correct temperature maintains its core temperature according to Afnor Standards. Automatic defrosting guarantees evaporators clearance and efficient well cooling. Digital control with temperature display with precise adjustment (0,1°C). Fully compliant HACCP digital controls include visible alarms. The bottom is equipped with copper tubes to ensure proper cooling, with this system the air touches the cold surface and gets cooled. Equipped with a drain hole to easily discharge top condensation. Wells in 304 AISI stainless steel with rounded corners to facilitate cleaning operations. The well is also equipped with a drain hole. High-density expanded polyurethane foam with cyclopentane guarantees excellent well insulation to reduce energy dispersion. Preadjusted connection to remote cooling unit (not included). Refrigerant type R452a other gases are available on request.

### Main Features

- Preadjusted connection to remote cooling unit (not included).
- CB and CE certified by a third party notified body.
- Designed to be positioned in flush installation providing improved cleanability and suitable for modern design installations.
- Precise temperature control and setting at 0,1°C .
- As standard the product comes with digitally controlled thermostat which is in line of HACCP norms and provides visual alarm as a warning of the increasing or decreasing temperatures.
- Available drop-in dimensions: 1, 2, 3, 4, 5, 6 GN.
- Food introduced at the correct temperature maintains its core temperature according to Afnor Standards.
- Automatic defrosting guarantees evaporators clearance and efficient well cooling.
- Designed to serve the food on plates .
- Equipped with a drain hole to easily discharge top condensation.
- Surface mat is available as an accessory.
- Built-in cooling unit version is available.

### Construction

- Well bottom is inclined to facilitate water drainage.
- Environmentally friendly: R452a as refrigerant gas.
- Well in 304 AISI stainless steel with rounded corners to facilitate cleaning operations. The well is also equipped with a drain hole.
- Electronic control with temperature display.
- IPx2 water protection.
- The bottom is equipped with copper tubes to ensure proper cooling, with this system the air touches the cold surface and gets cooled.
- Pressed Stainless steel top 30mm deep with rounded edges and drain hole for easier cleaning.

### Sustainability

- High-density expanded polyurethane foam with cyclopentane guarantees excellent well insulation to reduce energy dispersion.



APPROVAL: \_\_\_\_\_

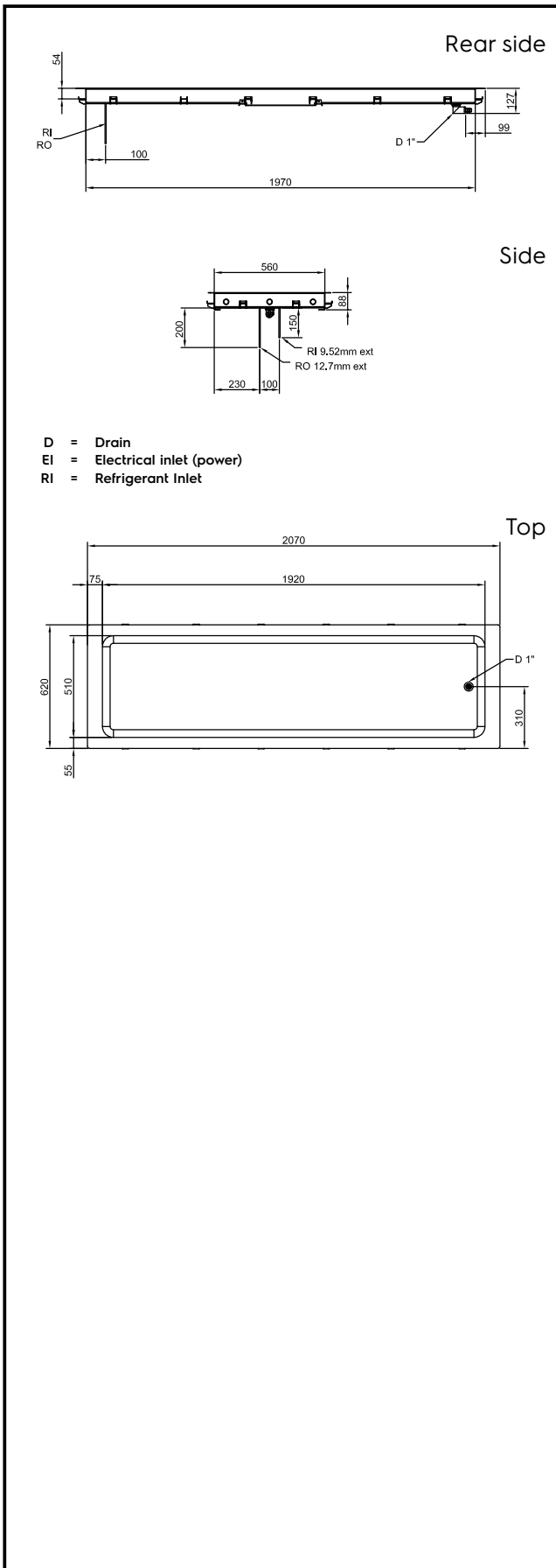

#### Electric

Supply voltage:

341113 (D14R6)

220-240 V/1N ph/50 Hz

Electrical power max.:

0.02 kW

#### Water:

Water drain outlet size:

1"

#### Key Information:

External dimensions, Width: 2070 mm

External dimensions, Depth: 620 mm

External dimensions, Height: 90 mm

Net weight: 36.6 kg

Shipping weight: 66 kg

Shipping height: 570 mm

Shipping width: 660 mm

Shipping depth: 2100 mm

Shipping volume: 0.79 m<sup>3</sup>

Set temperature: -10 / 0 °C

#### Refrigeration Data

Refrigerant type: R452A

Connection pipes (remote) - outlet:

12.7 mm

Connection pipes (remote) - inlet:

9.52 mm

#### Sustainability

Noise level:

0 dBA

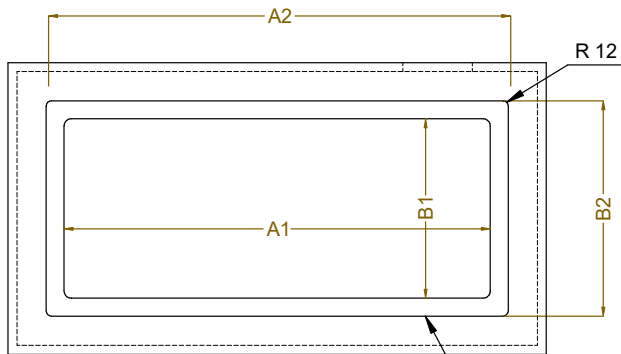
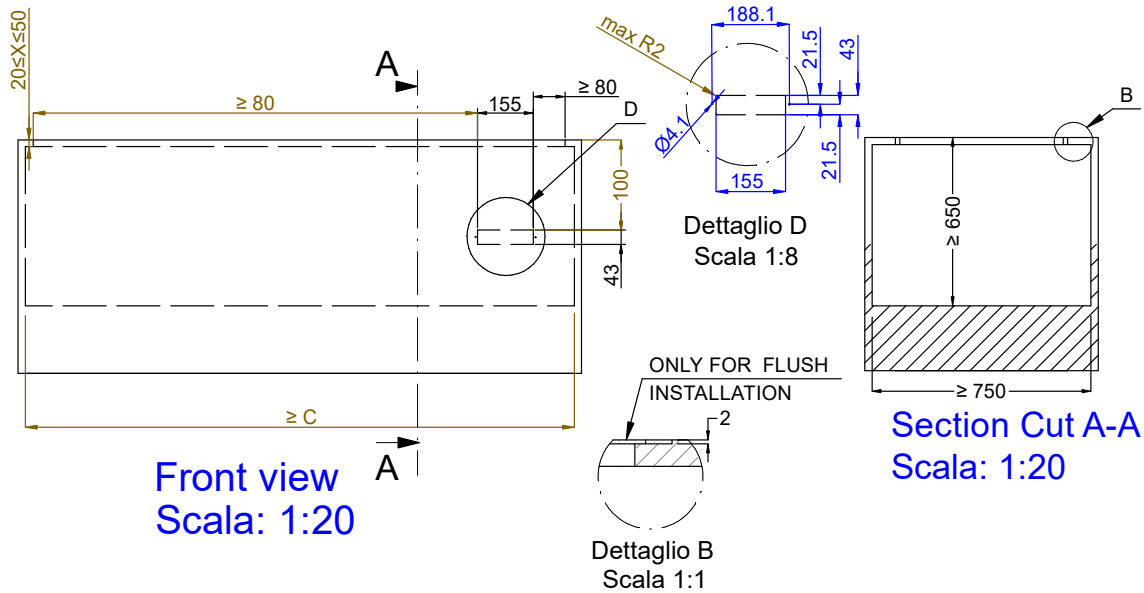

CAPACITY	CUTOUT		LOWERING FOR FLUSH INSTALLATION		C
	A1	B1	A2	B2	
1GN	370	580	454	624	550
2GN	690		774		870
3GN	1020		1104		1200
4GN	1340		1424		1520
5GN	1660		1744		1840
6GN	1990		2074		2170

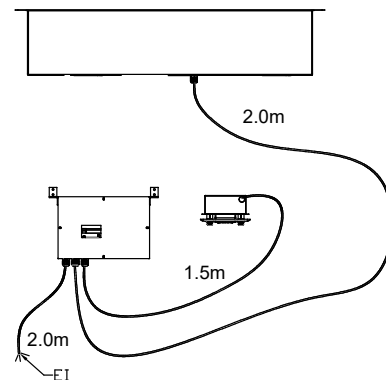
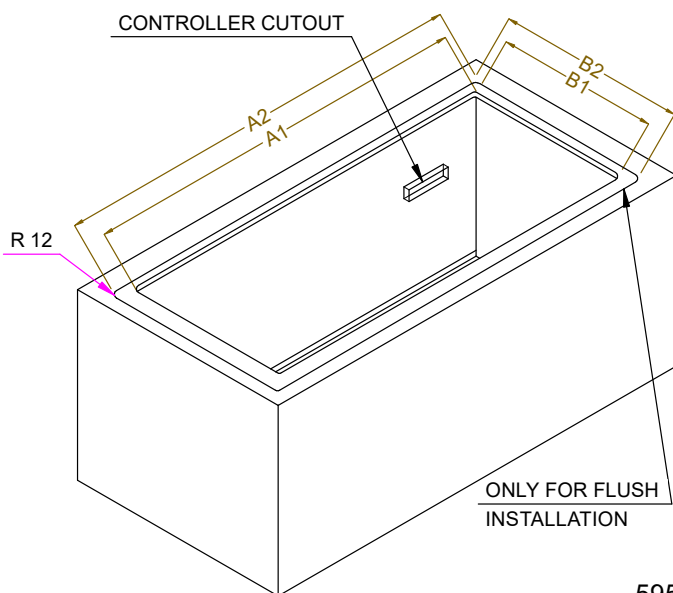

595T01Z00 - COLD S/S SURFACE REMOTE